

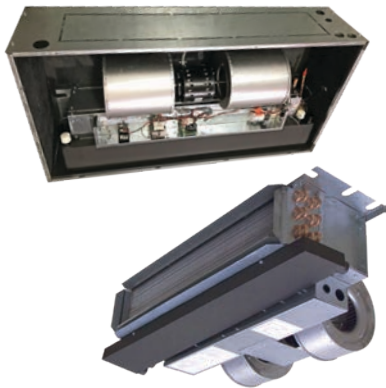

INSTALLATION GUIDE

PAT & PAS Series - Horizontal Ceiling Mount Electric Heat Dx Cool Air Handler



1. Safety Instruction

Potential safety hazards are alerted using the following symbols. The symbol is used in conjunction with terms that indicate the intensity of the hazard.



WARNING

This symbol indicates a potentially hazardous situation, which if not avoided, could result in serious injury, property damage, product damage or death.



CAUTION

This symbol indicates a potentially hazardous situation, which if not avoided, may result in moderate injury or property damage.



WARNING

Certified technicians or those individuals meeting the requirements specified by NATE may use this information. Property and product damage or personal injury hazard may occur without such background.



WARNING

All power sources should be disconnected prior to servicing. Failure to do so may cause personal injury or property damage.



WARNING

Product designed and manufactured to permit installation in accordance with local and national building codes. It is the installer's responsibility to ensure that product is installed in strict compliance with national and local codes. Manufacturer takes no responsibility for damage (personal, product or property) caused due to installations violating regulations. In absence of local/state codes, refer to National Electric Code: NFPA 90A & 90B Uniform Mechanical Code.



WARNING

When this unit is installed in an enclosed area, such as a garage or utility room with any Carbon Monoxide producing devices (i.e. automobile, space heater, water heater etc.) ensure that the enclosed area is properly ventilated.



CAUTION

Only factory authorized kits and accessories should be used when installing or modifying this unit unless it is so noted in these instructions. Some localities may require a licensed installer/service personnel.



WARNING

Unit is not approved for outdoor installations.



WARNING

The unit is designed for operation with 208/240 V, single phase, 60 Hz power supply. Aspen will not be responsible for damages caused due to modification of the unit to operate with alternative power sources.

2. Introduction

The PAT & PAS Series air handlers are versatile horizontal ceiling mount units. These air handlers have the following standard features:

I. Application Versatility

Louvered ceiling access panel has separate frame that attaches to ceiling joists. Solid access panel available for use with end return installations. Compatible with most brands of air conditioners or heat pumps.

II. Motor

Direct drive multi-speed blowers circulate air quietly and efficiently. 2-speed motors allow for precise air volume selection. Motor speeds can be easily selected via motor terminals. Blowers are mounted on a plate so they can be easily removed for service.

III. Cabinet (PAT Only)

Sturdy, fully insulated galvanized steel cabinet. Knockout for duct return.

IV. Electric Heat Kits

Available in 3, 4, 5, 6, 8, & 10 KW. Models with electric heat include sequencers and temperature limit switches for safe, efficient operation. Easily accessible controls for quick service. Electrical connections can be made from the top or left. Fan time delay relay standard for increased efficiency.

V. Electronic Circuit Board

Electronic circuit board provides 30 secs ON/OFF blower time delay extracting more heat/cool from the coil.

VI. DX Coil

High efficiency rifled copper tubes/enhanced aluminum fins provide maximum heat transfer. All coils immersion tested at 500 psi then nitrogen pressurized and factory sealed for maximum reliability. 3/4" suction line and 3/8" liquid line. Liquid line Schrader allows pre-installation pressure testing. Available with either orifice or TXV metering device. Field-installable bolt-on TXVs are also available. Primary & secondary condensate drain. All drain connections are 3/4" MPT. Access door allows for coil cleaning. Certified for use with either R22 or R410a.

VII. Warranty

One year limited parts warranty.

3. Inspection

✓ On receiving the product, visually inspect it for any major shipping related damages. Shipping damages are the carrier's responsibility. Inspect the product labels to verify the model number and options are in accordance with your order. Manufacturer will not accept damage claims for incorrectly shipped product.

4. Installation Preparation

Read all the instructions in this guideline carefully while paying special attention to the WARNING and CAUTION alerts. If any of the instructions are unclear; clarify with certified technicians. Gather all the tools needed for successful installation of the unit prior to beginning the installation.

4A. Clearances

The PAT & PAS series of horizontal ceiling mount air handlers are designed for zero clearance installation on the sides and back.

ENCLOSURES DIMENSIONS					
UNIT MODEL	A"	B"	C"	Weight (lbs)	Skid Qty.
PAT 23/26	40	30	30	125	5
PAT 27/31	46	36	36	135	5
PAT 28/29/34	52	42	42	145	5
PAT 35/38	60	48	48	155	5

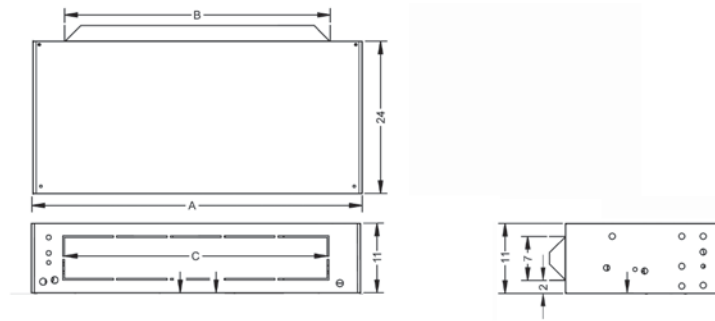

Fig 4A-1. Air Handler Dimensions

4B. Installation Options

If the unit is to be installed in garages, warehouses or other areas where they may be subjected to physical damage, adequate protective barriers must be installed. Unit **MUST** be installed 18" away from source of ignition.

If the unit is located in high humidity areas like attics or unconditioned garage; the air handler casing might experience nuisance sweating. In such installation scenarios, wrapping the casing with a 2" fiberglass insulation with vapor barrier **SHOULD** be used.

4C. Condensate Drain



CAUTION

Drain lines from the auxiliary drain pan should **NOT** be connected to the primary drain line of the coil.

The drain lines must be installed with 1/4" per foot pitch to provide free drainage. A condensate trap **MUST** be installed on the primary drain line to ensure proper drainage of the condensate. The trap must be installed in the drain line below the bottom of the drain pan (Fig. 4D-1)

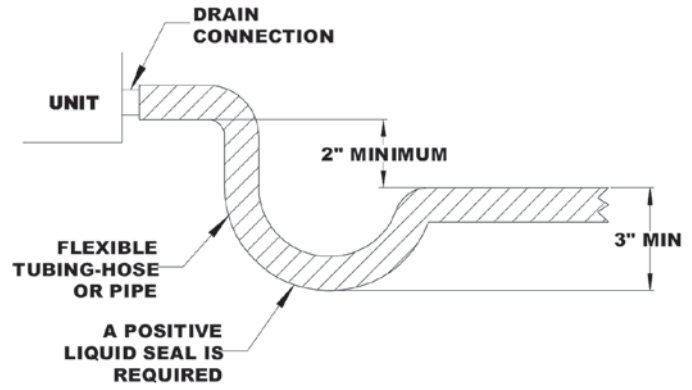

Fig 4D-1. Condensate Drain Trap



CAUTION

Since coil is upstream of the blower, all drains **MUST** be trapped or sealed. Failure to do so will result in condensate overflow from the drain pan. Aspen will **NOT** be responsible for any damages resulting from failure to follow these instructions.



CAUTION

If the drain pan is constructed of nylon or plastic; use Teflon tape to connect the drain lines to the threads in the drain pan. **DO NOT USE SOLVENT BASED PIPE DOPE. THIS WILL REDUCE THE LIFE OF THE PAN.**

The drain pan has primary (white) and secondary (red) drain connections. If a secondary drain line is required, it should be run separately from the primary and should terminate in a highly visible location. Condensate disposal through the secondary drain line indicates that the primary drain line is plugged and needs cleaning. If a secondary drain line will not be provided, plug the secondary drain. Drain plugs are **NOT** to be reused without plumbers tape or putty. Drain line connection should be finger tightened, then turned no more than one complete turn as needed to ensure a firm connection. **DO NOT** overtighten connection or damage may occur.

4D. Ductwork

Ductwork for air conditioning systems should be installed in accordance with standards of the National Fire Protection Association Pamphlet No. 90A or 90B, and also be sized in accordance with National Environmental System Contractors Association Manual K, whichever is applicable.

On any job, non-flammable flexible collars should be used for the return air and discharge connections to prevent transmission of vibration. Although these units have been specially designed for quiet vibration-free operation, air ducts can act as soundboards, and if poorly installed, amplify the slightest vibration to the annoyance level.

All main supply and return air drops should be properly size as determined by the designer of the duct system and should not necessarily be the size of the duct flange openings of the unit.

When installing a central air return grille in or near the living space, it is advisable to design the ductwork so that the grille is not in direct line with the opening in the unit. The use of one or two elbows and acoustical duct liner will also ensure quieter system operation.

It is recommended that wherever supply and return air sheet metal duct pass through unconditioned areas, they be insulated to prevent excessive heat loss during heating operation. When applied in conjunction with summer air conditioning, sheet metal duct routed through unconditioned areas should be insulated and have an outside vapor barrier to prevent formation of condensation.

5. Installation



CAUTION

Ensure that the unit is adequately sized. The tonnage of the outdoor unit should never exceed the tonnage of this unit.



WARNING

The coil was manufactured with a dry nitrogen pre-charge. Release the pressure through the Schrader valve test port prior to installation. If holding pressure is not present, return coil to distributor for exchange.



CAUTION

Some Aspen coils may include a Schrader valve on the suction manifold. Ensure that the Schrader valve/core (where present) are protected from heat during brazing and installation to prevent leakage. Use a core removal tool to temporarily remove the core when brazing. Replace the core once brazing is completed.

✓ Clean coil fins with degreasing agent or mild detergent and rinse fins clean prior to installation.

✓ The refrigerant line sizes should be selected according to the recommendations of the outdoor unit manufacturer.

✓ Care must be taken to ensure all connection joints are burr-free and clean. Failure to do so may increase chances of a leak. It is recommended to use a pipe cutter to remove the spun closed end of the suction line.

✓ To reduce air leakage, rubber grommets may be present where the lines pass through the coil case. To avoid damage, remove grommets prior to brazing by sliding over the lines. Use a quenching cloth or allow the lines to cool before reinstalling the grommets.

✓ Use of wet rags/quenching cloth is highly recommended to prevent weld-related damages to the casing and Schrader valve (if present).

✓ To ensure a low leakage installation, make certain that gaskets remain intact on all surfaces between the casing panels as shipped with the unit. Ensure enclosure or access panel is flush with the cabinet and openings around the water drain pipe and wiring access holes are sealed. The end return knock out should be sealed for bottom return applications.

6. Air Handler Orientation

The unit has pre-drilled holes for ceiling mounting.

6A. Mounting

To facilitate an easier installation, the blower/fan and heater/AC coil assemblies are removed prior to mounting the enclosure.

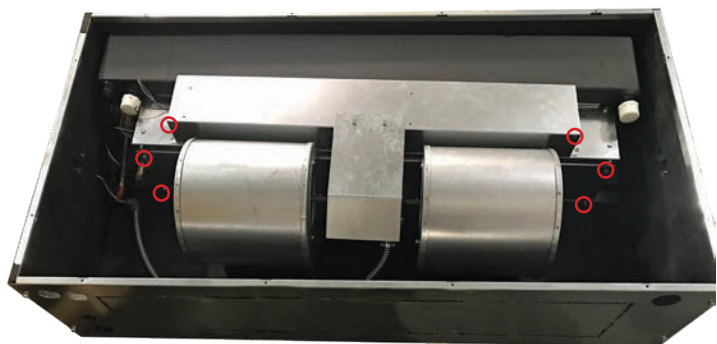

1. Using a 1/4" nut driver, remove the eight hex screws as shown in the picture above. Remove the control panel cover, disconnect the fan motor wiring, and remove the blower assembly.

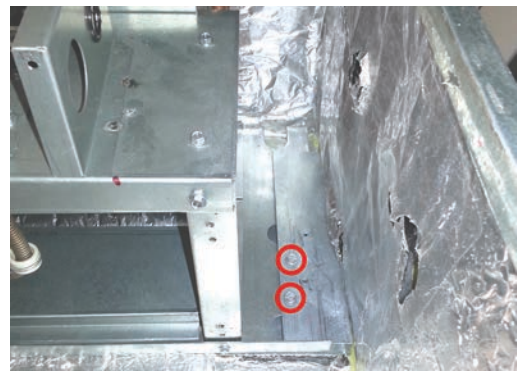

2. Using a 5/16" nut driver, remove the hex screws securing the heater/AC coil assembly to the slide brackets. The slide brackets are located on the left and right sides of the assembly. (Two screws per side)



3. Slide the heater/AC coil assembly out of the brackets and remove.



4. Mount the enclosure to the ceiling joists through the four mounting holes using four lag screws.

Installation Support Framing

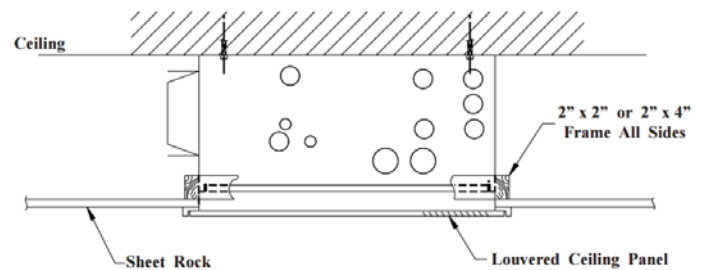

Ceiling Panel Frame Installation

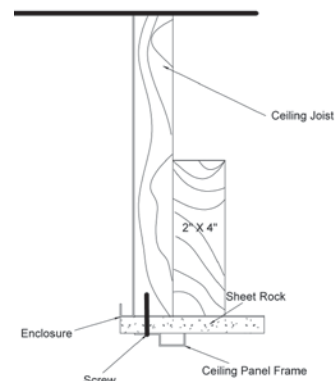

After the enclosure is mounted, a 2"x2" or 2"x4" frame MUST be installed around the base of the enclosure to create an airtight seal.



5. Ensure the unit is level to allow for proper condensate drainage.

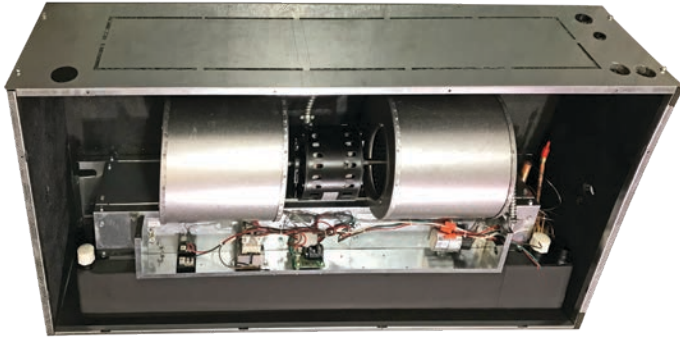

6. Reinstall the components removed prior to mounting the enclosure.

7. Connecting Ducting

1. Secure the supply air ducting to the duct flange of the air handler. Canvas connectors are recommended for reducing potential noise transmission.



7A. Remote/Ducted Return

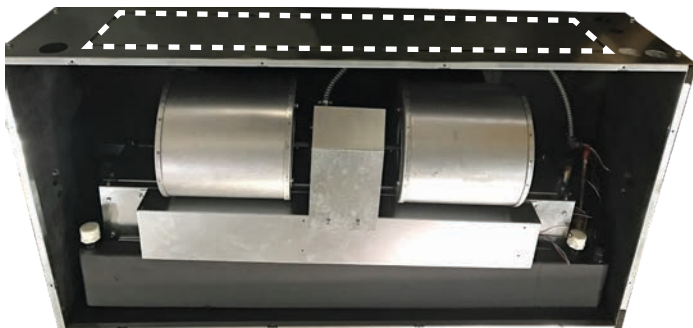

1. To connect return air ducting to the air handler, remove the knock-out and cut the insulation on the rear side of the enclosure to install the ducting.

7B. Bottom Return



1. A bottom return installation requires a louvered panel.



2. A ducted return requires a non-louvered panel.

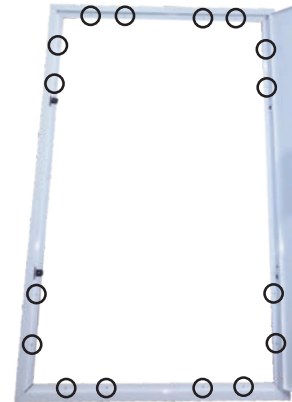

3. Both louvered and non-louvered panels are mounted to the ceiling using screws.

8. Metering Devices/Liquid Line Connection

Aspen coils are available with two kinds of metering devices a) flowrator or b) TXV. The following instructions are separated into sections by metering device.

8A. Flowrator Coils

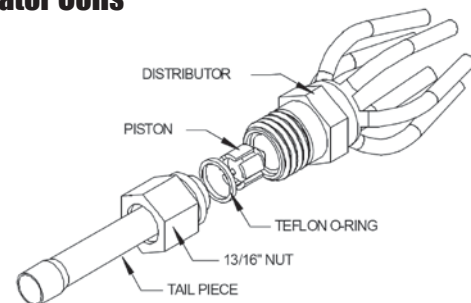

Fig 8A-1. Flowrator assembly components



CAUTION Use Piston sizes recommended by the outdoor unit manufacturer whenever possible. The piston should be sized according to the capacity of the outdoor unit.



WARNING Failure to install the proper piston can lead to poor system performance and possible compressor damage.

I. Installation

Note: Photos are for basic illustration purposes only. Actual equipment configuration may differ from that shown.



I-1. Disassemble flowrator body using two wrenches and unscrewing with a counterclockwise motion.



I-2. Replace the Teflon O-ring (located between the halves). Discard Schrader if present.



CAUTION Be aware of the Teflon O-ring. Be sure to replace the O-ring to attain a proper seal. (The Teflon O-ring is located between the two halves of the flowrator)



I-3. Slide the attachment nut onto the liquid line stub out.

I-4. Braze the stub-out portion to the liquid line and let cool.



I-5. Taking care that the white Teflon seal is still in place inside the flowrator body, firmly seat the stub and screw the attachment nut to flowrator body.

I-6. Tighten the nut to a torque of approximately 10-30 ft-lbs. Do NOT overtighten the nut. Overtightening will impede the piston movement during operation.

II. Piston Replacement

Note: Photos are for basic illustration purposes only. Actual equipment configuration may differ from that shown.



Fig 8A-2

During some installations, a piston change may be required. If so, the installer **MUST** change the piston. Use piston sizes recommended by the outdoor unit manufacturer. If a sizing chart is not available, use the piston size chart provided below to size the required piston. The size of the piston is stamped on the piston body (Fig 8A-2).

Use the chart below when matching coil with an outdoor unit with a different nominal capacity than the coil.

Outdoor Unit Capacity	R22 Orifice Size	R410a Orifice Size
12,000	0.041	N/A
18,000	0.055	0.049
24,000	0.059	0.055
30,000	0.068	0.059
36,000	0.074	0.068
42,000	0.080	0.074
48,000	0.084	0.080
60,000	0.092	0.089

II-1. Evacuate the system as per manufacturer guidelines and recommendations

II-2. Turn the 13/16" nut once to release any residual pressure in the coil.



II-3. After ensuring that the coil is free of any residual pressure, disassemble the flowrator body completely using two wrenches. Take great care not to distort the feeder tubes. The wrench used to clasp the nut should be turned in counter-clockwise direction to unscrew the nut.



II-4. Slide the 13/16" nut over the lineset and separate the two halves of the flowrator.

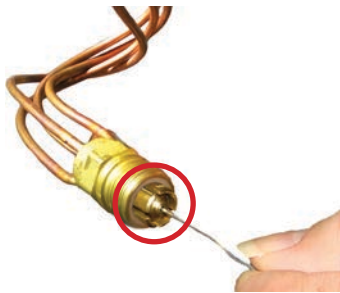

II-5. Pull the piston out using a small wire or pick. Verify the piston size (size is typically stamped on the body of the piston - Fig 8A-2). If a different piston size is required by the outdoor unit manufacturer, replace the piston using the small wire provided with the piston kit.



II-6. Replace the piston with one of the correct size. Do not force the new piston into the body. Make sure the piston moves freely in body.

CAUTION Pay close attention to the piston orientation. The pointed end of the piston **MUST** go into the distributor body, towards the coil. Failure to ensure this orientation will cause the piston to be bypassed during operation which might damage the outdoor unit.

II-7. Assemble the two halves correctly and ensure that the white Teflon O-ring is present between the two halves (See I-5). Slide the 13/16" nut onto the distributor body.

CAUTION Be aware of the Teflon O-ring. Be sure to replace the O-ring to attain a proper seal. (The Teflon O-ring is located between the two halves of the flowrator)

II-8. Tighten the nut to a torque of approximately 10-30 ft-lbs. Do NOT overtighten the nut. Overtightening will impede the piston movement during operation.

II-9. If present, slide the rubber grommet back to position to prevent air leakage.

8B. TXV Coils

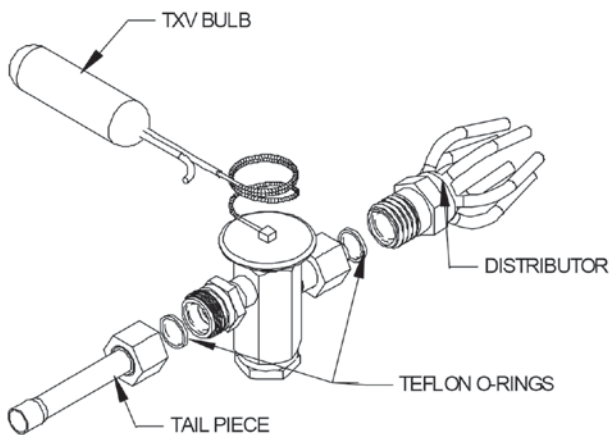

Fig 8B-1. Components of a typical TXV assembly

WARNING The sensing bulb and TXV body **MUST** be protected from overheating during brazing. The sensing bulb and TXV body must be covered using a quench cloth or wet cloth when brazing. Pointing the brazing flame away from the valve and sensing bulb provide partial protection only.

CAUTION Ensure that the TXV selected is compatible with the refrigerant used in the outdoor system (R22 or R410A). TXV caps are painted green for R22 or pink for R410A. In absence of color, the caps will be marked with the compatible refrigerant.

CAUTION The valves should be sized according to the capacity of the outdoor unit. Failure to install the right valve can lead to poor performance and possible compressor damage.

I. TXV Bulb Horizontal Mounting

The orientation and location of the TXV bulb has a major influence on the system performance.

CAUTION Ensure that the TXV bulb is in direct contact with the suction/vapor line. Gap between the bulb and tube should be avoided. Failure to do so will impair the proper functioning of the TXV valve.

It is recommended that the TXV bulb be installed parallel to the ground (on a horizontal plane). The bulb position should be at 2 o'clock or 10 o'clock. Fig. 7B-2 shows the recommended position for the TXV bulb installation in the horizontal plane.

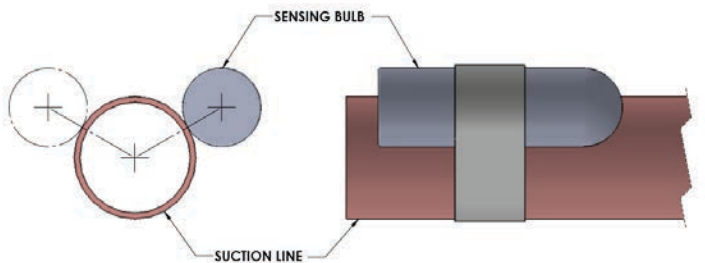

Bulb position at
2 o'clock or
10 o'clock

Fig 7B-2. Recommended location for horizontal TXV bulb mount

The TXV sensing bulb **SHOULD** be mounted on the suction line approximately 6" from the TXV or coil housing using the metal clamp provided. In order to obtain a good temperature reading and correct superheat control, the TXV sensing bulb must conform to ALL of the following criteria:

1. The sensing bulb **MUST** be in direct and continuous contact with the suction line.
2. The sensing bulb should be mounted horizontally on the suction line.
3. The sensing bulb **MUST** be mounted at the 2 o'clock or 10 o'clock position on the circumference of the suction line.
4. The sensing bulb **MUST** be insulated from outside air.

A properly mounted sensing bulb will prevent false readings caused by liquid refrigerant that may have formed inside the suction/vapor line. Insulation will protect the sensing bulb from false readings due to contact with warm air.

II. TXV Bulb Vertical Mounting

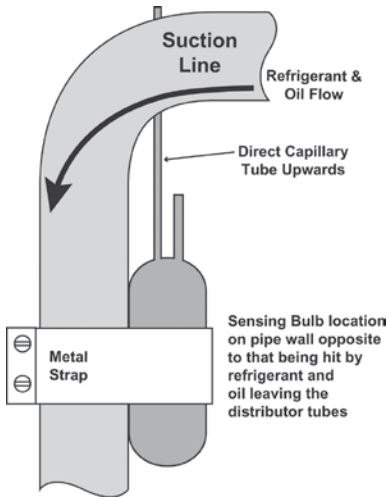

Fig 8B-3. Recommended location for vertical TXV bulb mount

As recommended in Section 8B-I, the TXV sensing bulb should be mounted in a horizontal plane in relation to the suction/vapor line. However, some installation configurations may require that the sensing bulb be mounted vertically. In this instance, place the bulb opposite the piping wall being hit by refrigerant and oil leaving the distributor tubes, and with capillary tubes directed upwards as shown in Fig. 8B-3.



CAUTION

If the TXV sensing bulb is mounted vertically, the capillary **MUST** be directed upwards. The bulb must be mounted on the wall opposite to that being directly hit by the refrigerant and oil leaving the distributor tubes.

III. Field-Installed TXV Retrofit

Note: Photos are for basic illustration purposes only. Actual equipment configuration may differ from that shown.

When installing an expansion valve, it is not necessary to slide the coil out of the housing.

For disassembly and piston removal refer to section 8A-I.

III-1. Inspect the TXV box to confirm that the valve is compatible with the refrigerant in the system.

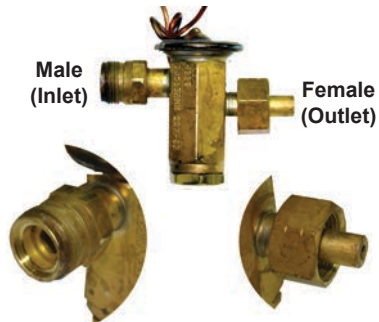

III-2. Remove the valve from the box and note the location of the inlet side (threaded male port) and the outlet side (female swivel nut port).



III-3. After ensuring that the Teflon O-ring seal is still in place inside the flowrator body, screw the female swivel nut onto the flowrator body.

III-4. Slide the attachment nut onto the liquid line stub out (See 8A, I-3)

III-5. Braze the stub-out portion to the liquid line and let cool.



WARNING

Do not attempt to touch brazed joints while hot. Severe burns may result.



III-6. Remove the additional Teflon O-ring seal from the box and place on the shoulder just inside the TXV inlet port. Screw the nut attached to the stub-out portion of the flowrator body onto the inlet port of the TXV.

III-7. Tighten all connections taking care to use proper back up.

III-8. Remove the valve identification sticker from the valve and place it adjacent to the model number on unit name plate.

III-9a. Some air handlers come with a Schrader valve on the suction line. **If a Schrader port is present:**



A. Remove the valve stem from the Schrader port mounted on the suction line.



B. Screw flare nut on TXV equalization tube on to the Schrader valve stem.

III-9b. In some cases, a suction line schrader port may not be present. **If a Schrader port is NOT present:**



A. Install a field-supplied braze-on schrader valve like that shown on the suction line near the intended sensing bulb mounting location. Follow valve manufacturer instructions and recommendations for installation.

B. Attach equalizer tube to valve as described in section III-9a above.

III-10. Mount the sensing bulb as described in section 8B-I or 8B-II.



CAUTION

When handling or manipulating the equalizer tube, take great care not to kink or make extreme bends in the tubing.

9. Connecting Refrigerant Lines



1. Release nitrogen holding charge by depressing the Schrader Valve at the liquid line connection on the air handler. If no gas releases from the air handler, contact distributor regarding potential leak.



2. Cut off Schrader Valve fitting at the liquid line connection. Use a tubing cutter for this step. Clean the burr from the cut tubing to reduce the chance of future leaks. Connect the liquid line to the tubing at the indoor unit.



3. Use a tubing cutter to remove the spun end from the suction line connection at the air handler. Clean the burr from the cut tubing to reduce the chance of future leaks.

4. To avoid heat damage to grommets where present, remove these prior to brazing by sliding them over the refrigerant lines and out of the way.



5. Check to determine if the evaporator coil has a Schrader fitting on the suction manifold. If yes, remove the valve core to prevent heat damage during brazing. Replace the valve core once the piping has cooled.

6. If the air handler has a TXV metering device, remove the sensing bulb from the suction line prior to brazing to prevent heat damage from occurring. Replace the sensing bulb once the piping has cooled.



7. Flow nitrogen through the piping when brazing.
8. Braze both refrigerant line connections using proper brazing procedures.
9. When all line connections are brazed, perform a proper system evacuation procedure per the outdoor unit manufacturer instructions.
10. Seal the penetration openings where the lineset piping enters the air handler cabinet.

10. Leak Check

1. Following outdoor unit manufacturer instructions and recommendations, charge the system with dry nitrogen to a maximum pressure of 150 PSIG.

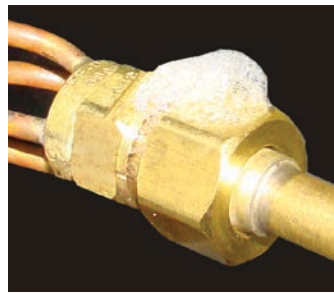

2. Check all brazed and screw-on line connections by applying a soap solution to the joint. A leak will produce bubbles in the soap solution.

3. If any leaks are discovered, relieve system pressure and repair leaks. Repeat steps 1-3.

4. With no leaks or weak connections present, evacuate the system and charge as per the outdoor unit manufacturer instructions and specifications.

11. Electrical Installation

These units are designed for a single phase 208/240 volts, 60 Hz power supply. Wire selection and wiring must be in accordance with the National Electric Code and/or local codes. Unit terminals are designed to accommodate copper or aluminum wiring. If aluminum wiring is used; please observe special precautions relative to sizing, wire connections and corrosion protection.

Fig.11-1 shows the typical electrical connections required for A/C only and heat pump applications.

All models with 3, 5, 8 or 10 kW electric heat are arranged for single circuit connections. Fig. 11A-2 shows the typical electrical connections required for A/C only and heat pump applications.

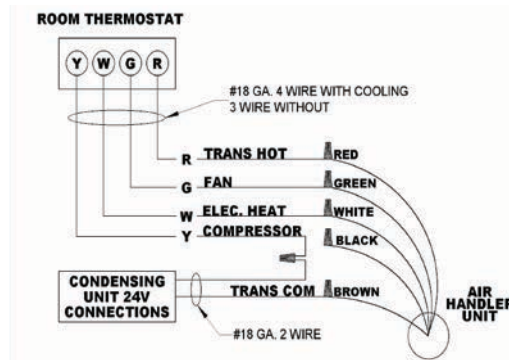
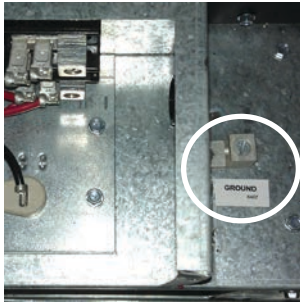

Fig 11-1.

Line voltage wiring should be routed through the access holes at the side of the air handler. Proper electrical conduit connection fittings should be used. Connect the power wiring to the line side connections on the air handler. The electrical ground wire should be connected to the grounding lug. Ensure both the field supplied ground wire and air handler GREEN ground wire are both secured to the grounding lug of the air handler (Fig 11-2).

Fig 11-2.



If the line voltage being supplied to the air handler is 208 volt single phase, the line voltage tap on the low voltage transformer needs to be moved from the 240 volt tap to the 208 volt tap. If this is not done, the secondary output voltage of the transformer will be too low (Fig 11-3).

Fig 11-3.

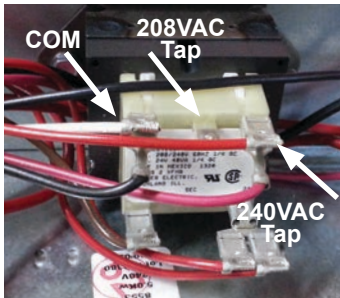

11A. Single Stage Cooling

During cooling mode operation, indoor blower wire "G" will energize a time delay relay located on the control board inside the air handler. After a short time delay period, the time delay relay will apply 240VAC to the motor via the "MTR" terminal. (See Schematic Fig 20-1.) Fan time delay periods are 7 seconds ON delay and 65 seconds OFF delay.

The Y wire from the thermostat is not connected at the air handler. This wire goes directly to the outdoor unit 24 volt wiring to turn on the outdoor condensing unit when a call for cooling takes place. The 24 volt common for the outdoor unit circuitry is connected at the air handler brown wire. (See Fig 11-1.)

The heater low voltage wiring terminal "W" is wired directly from the thermostat to the air handler. The indoor blower, on a call for heat, will ON delay for a period of 5 seconds. When the call for heat has been satisfied, the indoor blower will have an OFF delay time period of 60 seconds.

Final air volume adjustments should be made by referencing total external static pressure (found in product specifications.).

11B. Heat Pump Application

11B. Heat Pump Application:

Installation of heat pump kit (HPK-001) is required for highlighted cases of Heat Pump applications with emergency electric heat. Re-fer chart below for applicable cases. Aspen also recommends field personnel to evaluate applicability of the heat pump kit on a case by case basis.

Electric Heater Size (kW)					
PAT/PAS	10	8	6	5	3
23					
26					
27					
28					
29					
33					
34					
35					
38					

12. Condensate Drain

1. Select desired condensate drain openings according to air handler orientation. Both Primary and Secondary outlets can be used.
2. Pipe condensate system using proper PVC fittings.
3. Ensure a minimum 2" trap is installed in the condensate drain. Locate the trap near to the connection opening on the air handler. See illustration.

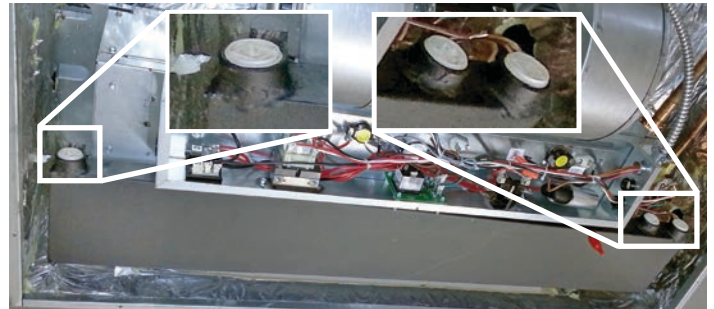

13. Air Volume Adjustment

Air volume needs to be set to the level recommended by the outdoor unit equipment manufacturer. Most systems will require around 350-400 CFM of indoor air for every 1 ton of system cooling capacity. The air volume must be set prior to attempting system charge.

This air handler uses a PSC type motor. The speed of this motor is set by placing the appropriate winding lead wire on the "MTR" terminal of the control board. Unused motor winding leads are to be placed on the "BLANK" terminals on the control board. The air volume level produced by the air handlers at varying external static pressure levels is shown in Table 11A-1. Use a Magnehelic Gauge with a 1" scale and two static pressure tips to measure the static pressure during the air volume adjustment procedure. The high port static pressure tip should be placed in the supply duct near the outlet of the air handler. The low port static pressure tip should be placed in the return air duct near the entrance to the air handler.

Use a Magnehelic Gauge with a 1" scale and two static pressure tips to measure the static pressure during the air volume adjustment procedure. The high port static pressure tip should be placed in the supply duct near the outlet of the air handler. The low port static

pressure tip should be placed in the return air duct near the entrance to the air handler. The factory provided air filter should be in place inside of the air handler.

1. Select a speed tap from the CFM table and connect appropriate motor lead wire to the "MTR" terminal on the control board.
2. Call for fan only operation at the thermostat.
3. Read the external static pressure level on the Magnehelic gauge.
4. Make speed tap selection change to get the air volume as close as possible to the required level.
5. If the static pressure is above .5" wc, excessive turbulence or duct friction needs to be reduced. (Obstructions in the duct system can also cause excessive static pressure.)
6. When proper air volume is established, move on to the charging procedure.

14. System Charging



CAUTION

An improperly charged system may cause degradation in system performance and damage the compressor. After installation of the coil, refer to the outdoor unit manufacturer for charging techniques and amount of charge. If outdoor unit manufacturers charging instructions are unavailable, then refer to instructions below to charge the system.

1. Bring airflow up to the maximum CFM possible according to Table 11A-1.
2. Evacuate refrigeration system to micron level required by outdoor unit manufacturer.
3. Release system charge from outdoor unit and call for cooling.
4. Use outdoor unit equipment manufacturer specific charging charts if available and make proper charge adjustment based upon outdoor unit instructions.
5. If outdoor unit instructions and charts are not available, use Air-Mark provided charts. Make certain indoor air temperature is near comfort level setpoint of 75°F prior to establishing superheat and subcooling levels.

14A. Flowrator Coils

Add refrigerant until the superheat measured at the outdoor unit suction/vapor line matches the superheat from the chart below.

Outdoor Temp	Superheat		
	°F D.B.	Min	Nom
65	30	35	40
70	26	30	34
75	21	25	29
80	17	20	23
85	12	15	18
90	8	10	12
95	4	5	7
100			

Table 14B-1.

14B. Expansion Valve Coils

Add refrigerant until the subcooling measured at the outdoor unit liquid line matches the subcooling recommendation of the outdoor manufacturer. If chart is unavailable charge the unit to a subcooling value of 8°F +/- 1°F.

15. Adjustment Of Heat Anticipator

After all connections are made, start-up and checkout must be performed before proper evaluation of the entire system can be made. Make sure that heat anticipator is properly set as noted on thermostat instructions. Load requirements can vary in each residence and it may be necessary for the installer or homeowner to make slight adjustments to the heat anticipator setting for longer or shorter cycles. It is recommended to change the setting no more than plus or minus 0.05 amps at a time. Greater changes can cause the unit to rapid cycle or remain on excessively.

16. Start-Up

To properly check the unit's operation, the installer should have an electrical current measuring device (0-10 amp Amprobe, Fluke), air pressure measuring device (0-1.0 in slope gauge), and a temperature-measuring device (0-200°F thermometer).

Install the Amprobe to measure blower current, the slope gauge to measure static air pressure at the units and the temperature device to measure unit supply and return air temperature. Before taking measurements, be sure that all registers, grilles and dampers are open or set to their proper positions. Be sure that clean filters are in place. Temperature measuring device must be installed to obtain average temperature at both inlet and outlet. For outlet, measure temperature of each main trunk at a location far enough away to avoid heater radiation and read the average temperatures. Table 11A-1 shows the CFM that should be achieved at various external static pressures

17. Checking Air Flow/Temperature Rise Method

Turn on power supply. Set thermostat fan switch to on. Set the cooling indicator to maximum, heating to minimum. System switch may be on heat or cool. Check slope gauge measurement against appropriate air flow chart. Make damper, register and motor speed adjustments to obtain required airflow.

Set thermostat fan switch to auto, system to heat and thermostat heating indicator to maximum heat. Blower should start and all heat be energized.

Check air flow using temperature rise method.

$$CFM = \frac{OUTPUT(BTUH)}{1.08 \bullet TEMP.RISE}$$

NOTE: BTUH output should be computed by VOLT x AMPS x 3.4 = BTUH OUTPUT. Since line volt can vary, do not use nameplate rating to determine output.

18. Operation and Maintenance

Below are brief descriptions of the key components of the unit and installation. This manual only provides general idea of the components and recommended practices. The installer should use best judgment to ensure safe installation and operation of the unit.

1. Room Thermostat- This is the device that controls that operation of your heating and/or cooling unit. It senses the indoor temperature and signals the equipment to start or stop maintaining the temperature you have selected for your comfort. The room thermostat should be in a central, draft free inside wall location for best operation. Do not place any heat producing apparatus such as lights, radio, etc., near the thermostat as this will cause erratic operation of the comfort system. The thermostat can accumulate dust or lint which can affect its accuracy. It should be cleaned annually.

2. Air Filter(s) - All central air moving comfort systems must include air filter(s). These filters will be located either in the equipment or in the return air duct system upstream of the equipment. The filter(s) removes dust and debris from the air thus helping to keep your air-conditioned space clean. More important, the filter keeps dust and debris from collecting on the heat transfer surfaces thus maintaining optimum equipment efficiency and performance. Inspect and clean or replace filters every month. This routine maintenance procedure will pay big dividends in reduced operating cost and reduced service expense. Never operate comfort equipment without filter(s).

3. Fuses and/or Circuit Breakers- This comfort equipment should be connected to the building electric service in accordance with local and National Electric codes. This electrical connection will include over-current protection in the form of circuit breakers. Have your contractor identify the circuits and the location of over-current protection so that you will be in a position to make inspections or replacements in the event the equipment fails to operate.



WARNING

4. a) Do not store combustible materials or use gasoline or other flammable liquids or vapors in the vicinity of this appliance.

b) Do not operate the comfort equipment with panels removed.

c) Have your contractor point out and identify the various cut-off devices, switches, etc., that serve your comfort equipment. There is a main switch that will cut off energy to your heating system. Know where they are so that you may cut off the flow of energy in the event of overheating.

5. Periodic Checkup and Service- This product is designed to provide many years of dependable, trouble-free comfort when properly maintained. Proper maintenance will consist of annual check-ups and cleaning of the internal electrical and heat transfer components by a qualified service technician. Failure to provide periodic checkup and cleaning can result in excessive operating cost and/or equipment malfunction.

6. Lubrication- Direct drive blower motors are equipped with permanently lubricated bearings and do not require further lubrication.

7. Air filter replacement: An air filter can restrict the airflow of air to the fan coil if it is not cleaned or replaced periodically. When replacing the air filter, always replace with the same type and size as originally furnished with the unit.

19. Final System Checkout

1. Make certain all cabinet openings are properly sealed and any grommets moved during installation are moved into proper place.
2. With cooling system operating, check for condensate leakage.
3. Perform leak detection inspection of refrigerant circuit and connecting piping.
4. Secure all cabinet doors.

20. Wiring diagram for 00-10 kW heating PAS/PAT models

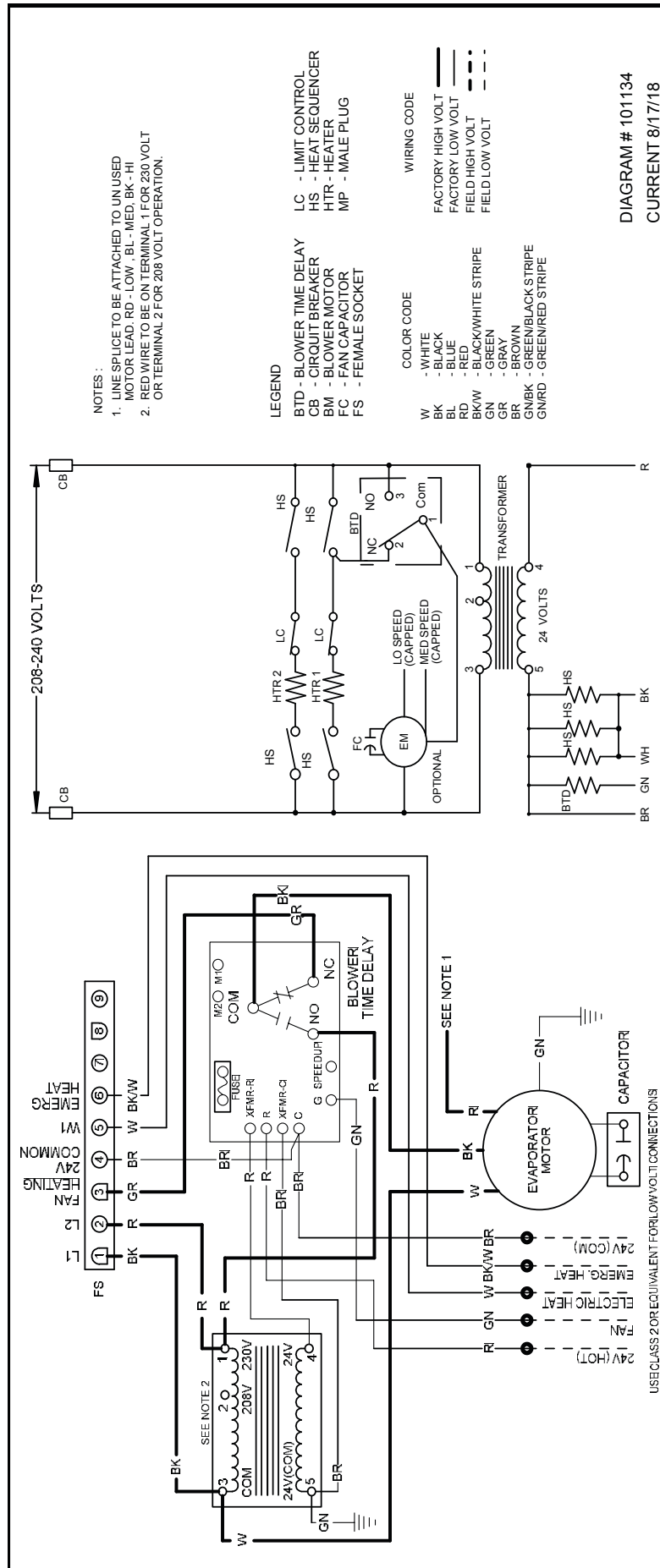



373 Atascocita Rd.
Humble, TX 77396
Phone: 281.441.6500
Toll Free: 800.423.9007
Fax: 281.441.6510
www.aspenmfg.com



Revised 12/08/21. Subject to change without notice and without incurring obligation.

© Copyright 2021 Aspen Manufacturing. All Rights Reserved